

PLAN

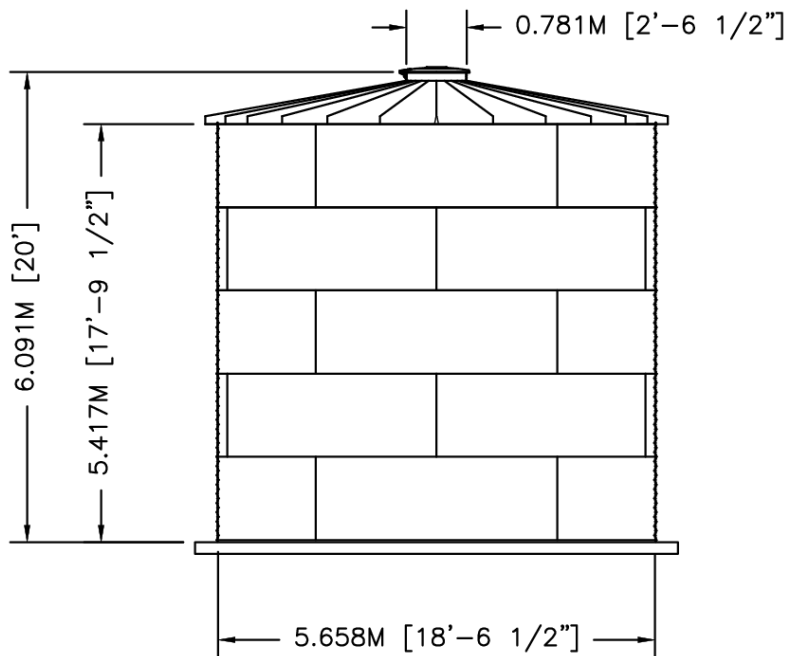

ELEVATION



	BY	DATE	TITLE	
DWN	XXX	XX/XX/XX	WTU06-05 30"PR 10DEG V-RIB	
CKD			NOMINAL CAPACITY - 133.133 M3 [35,170 GAL]	
ENG			DWG. NO. SCT1805-LVR WTU06-05	REV. NO.
	SIZE:	SCALE:	SHEET	OF
	A	1/8"=1'-0"	1	1